

# Trazos básicos de los caracteres chinos

(一)

héng

橫



shù

豎



piě

撇



diǎn

点



nà  
捺



# Xiān héng hòu shù

## 1、先横后竖

Primero horizontal, luego vertical



shí

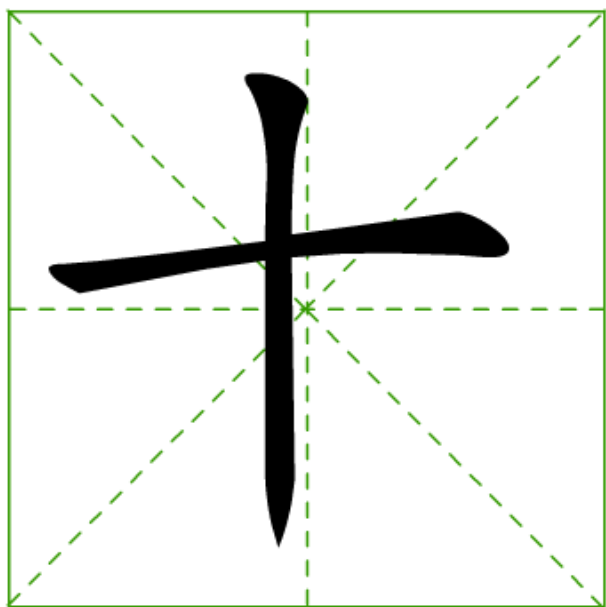

笔顺 笔画 偏旁部首 组词

EXIT



gōng

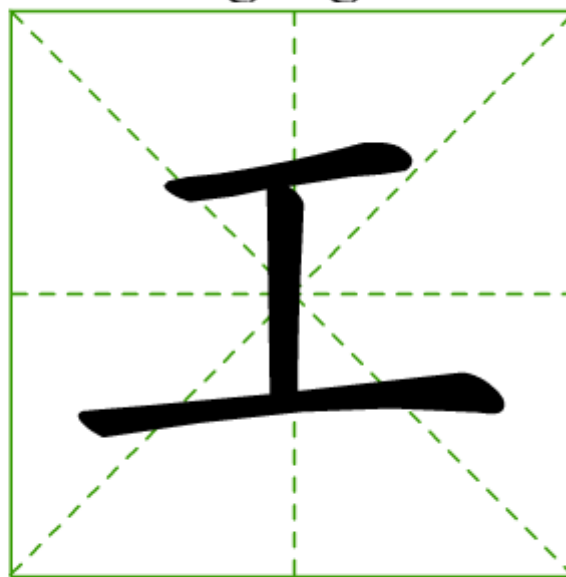

笔顺 笔画 偏旁部首 组词

EXIT



# Xiān piě hòu nà

## 2、先撇后捺

Trazar primero " piě " y



bā

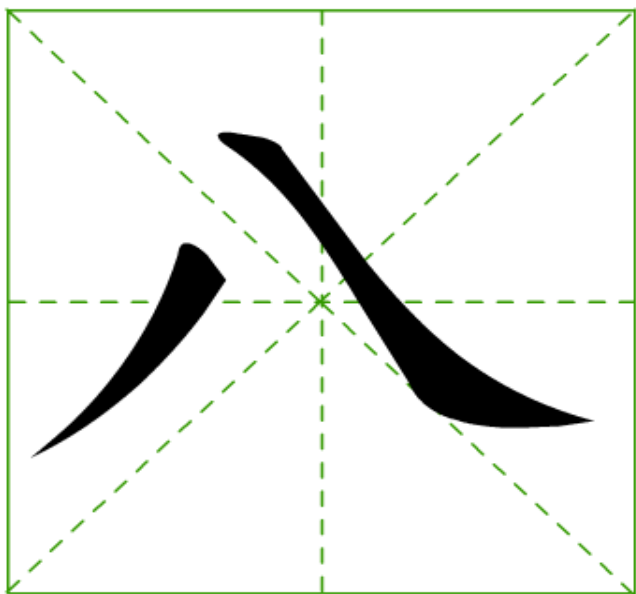

笔顺

笔画

偏旁部首

组词

EXIT



rén

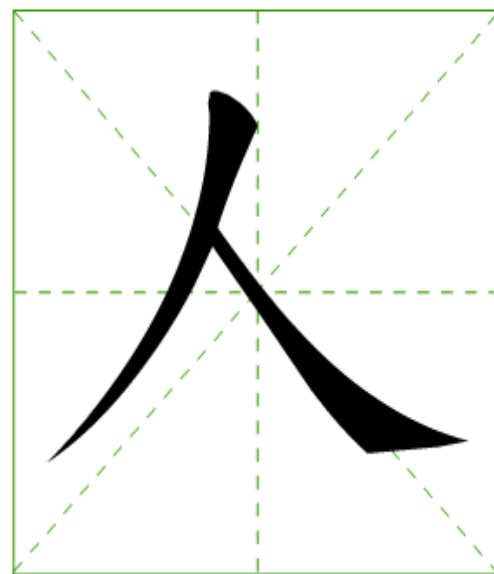

笔顺

笔画

偏旁部首

组词

EXIT



# Xiān shàng hòu xià

## 2、先上后下

### De arriba hacia abajo



liù

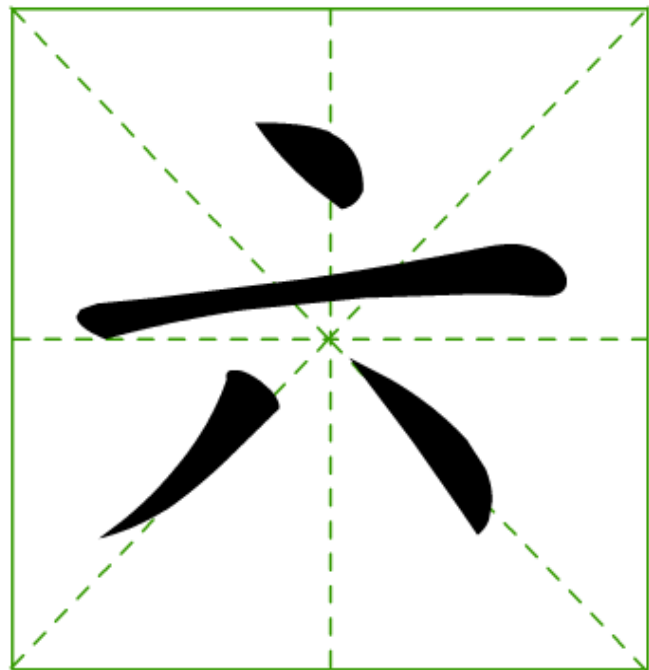

笔顺 笔画 偏旁部首 组词

EXIT



bù

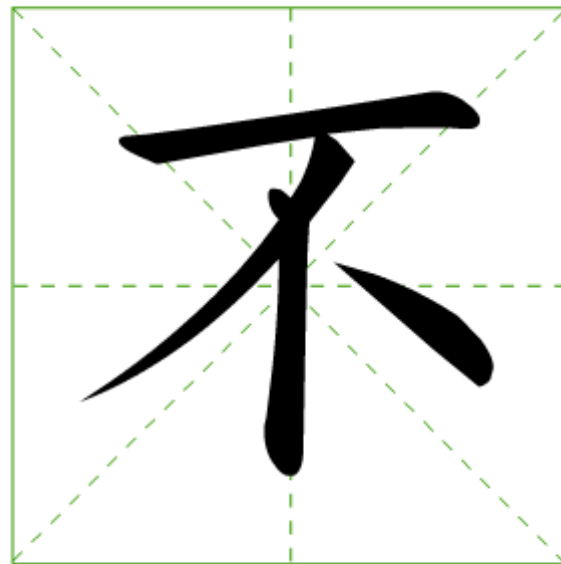

笔顺 笔画 偏旁部首 组词

EXIT



# Xiān zuǒ hòu yòu

## 4、先左后右

De izquierda a derecha



nǐ

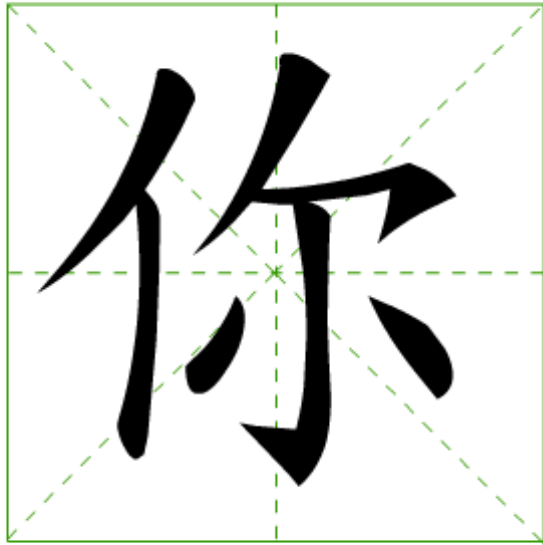

笔顺

笔画

偏旁部首

组词

EXIT



hǎo

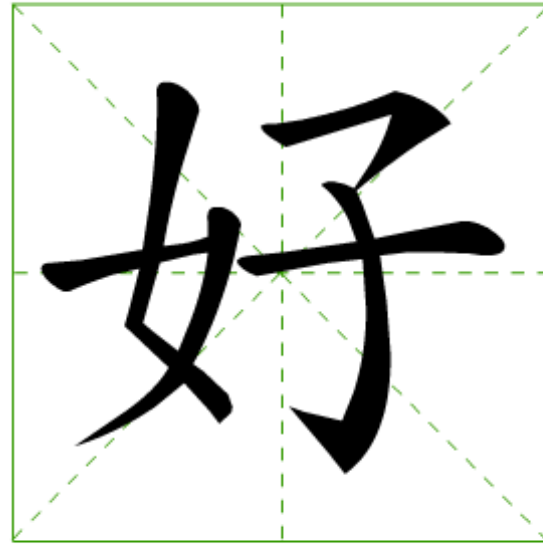

笔顺

笔画

偏旁部首

组词

EXIT



# Aprender y escribir caracteres chinos básicos.

yī 

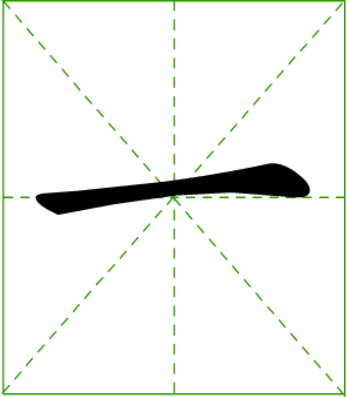

笔顺 笔画 偏旁部首 组词

EXIT 

èr 

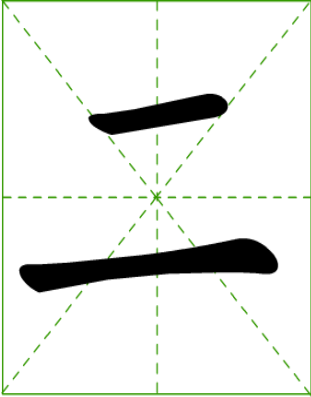

笔顺 笔画 偏旁部首 组词

EXIT 

sān 

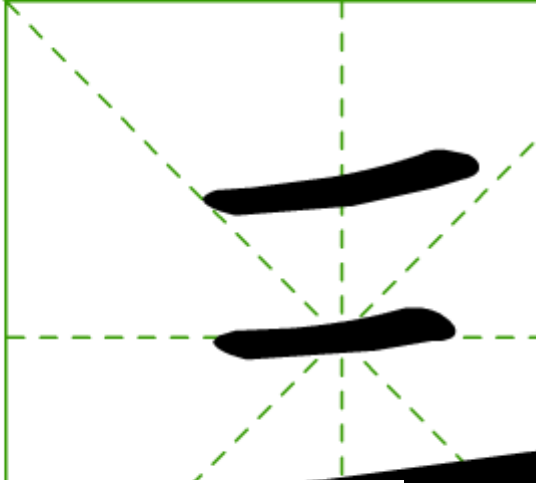

shí 

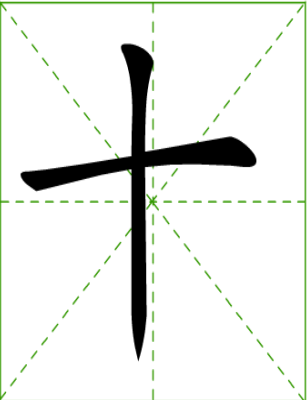

笔顺 笔画 偏旁部首 组词

EXIT 

bā 

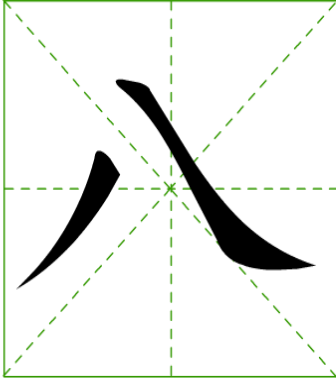

笔顺 笔画 偏旁部首 组词

EXIT 

liù 

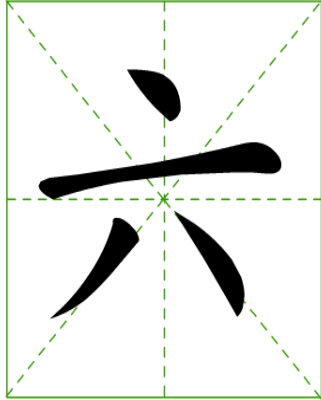

笔顺 笔画 偏旁部首 组词

EXIT 

部首